

# Spezifikation für Freigabe / specification for release

Kunde / customer : \_\_\_\_\_  
 Artikelnummer / part number : **744311220**  
 Bezeichnung : **SPEICHERDROSSEL WE-HC**  
 description : **POWER-CHOKE WE-HC**

LF



DATUM / DATE : 2008-01-01

## A Mechanische Abmessungen / dimensions :

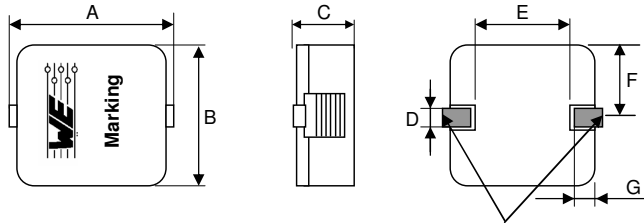

RDC is measured at these points

A	<b>7,0 ± 0,3</b>	mm
B	<b>6,9 ± 0,3</b>	mm
C	<b>3,8 +0,2/-0,3</b>	mm
D	<b>1,2 ± 0,3</b>	mm
E	<b>2,5 ± 0,3</b>	mm
F	<b>3,45 ± 0,3</b>	mm
G	<b>1,8 ± 0,3</b>	mm

Marking = part number

## B Elektrische Eigenschaften / electrical properties :

Eigenschaften / properties	Testbedingungen / test conditions		Wert / value	Einheit / unit	tol.
Lerrlaufinduktivität / initial inductance	100 kHz / 0,1V	L <sub>0</sub>	<b>2,20</b>	μH	± 20%
Nenn-Induktivität / rated inductance	100 kHz / 0,1V / 9A	L <sub>N</sub>	<b>1,75</b>	μH	typ.
DC-Widerstand / DC-resistance	@ 20 °C	R <sub>DC</sub>	<b>11,40</b>	mΩ	± 10%
Nennstrom / rated current	ΔT= 50 K	I <sub>N</sub>	<b>9,0</b>	A	typ.
Sättigungsstrom / saturation current	ΔL/L <sub>0</sub> = 30 %	I <sub>sat</sub>	<b>13,0</b>	A	typ.
Eigenres.-Frequenz / self-res.-frequency		SRF	<b>52</b>	MHz	typ.

## C Lötpad / soldering spec.:

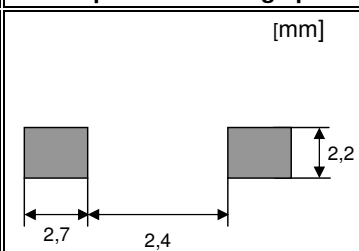

## D Prüfgeräte / test equipment :

WAYNE KERR 3260B für/for L<sub>0</sub>; R<sub>DC</sub>; I<sub>SAT</sub>; I<sub>N</sub>

## E Testbedingungen / test conditions :

Luftfeuchtigkeit / humidity: 33%  
 Umgebungstemperatur / temperature: +20 °C

## F Werkstoffe & Zulassungen / material & approvals :

Basismaterial / base material: WE-Superflux  
 Draht / wire: AIEIW-200  
 coating: black

## G Eigenschaften / general specifications :

Arbeitstemperatur / operating temperature: -40 °C - +150 °C  
 Umgebungstemp. / ambient temperature: -40 °C - +100 °C  
 It is recommended that the temperature of the part does not exceed 150 °C under worst case operating conditions.

Freigabe erteilt / general release:	<b>Kunde / customer</b>		
.....	Unterschrift / signature		
Datum / date	<b>Würth Elektronik</b>		
.....	ME	Version 3	08-01-01
.....	ME	Version 2	04-11-25
.....	ME	Version 1	04-10-10
Geprüft / checked	Name	Änderung / modification	Datum / date

### Würth Elektronik eiSos GmbH & Co. KG

D-74638 Waldenburg · Max-Eyth-Strasse 1 - 3 · Germany · Telefon (+49) (0) 7942 - 945 - 0 · Telefax (+49) (0) 7942 - 945 - 400  
<http://www.we-online.de>

# Spezifikation für Freigabe / specification for release

Kunde / customer : \_\_\_\_\_  
 Artikelnummer / part number : **744311220**  
 Bezeichnung : **SPEICHERDROSSEL WE-HC**  
 description : **POWER-CHOKE WE-HC**

LF



DATUM / DATE : 2008-01-01

## H Induktivitätskurve / Inductance curve :

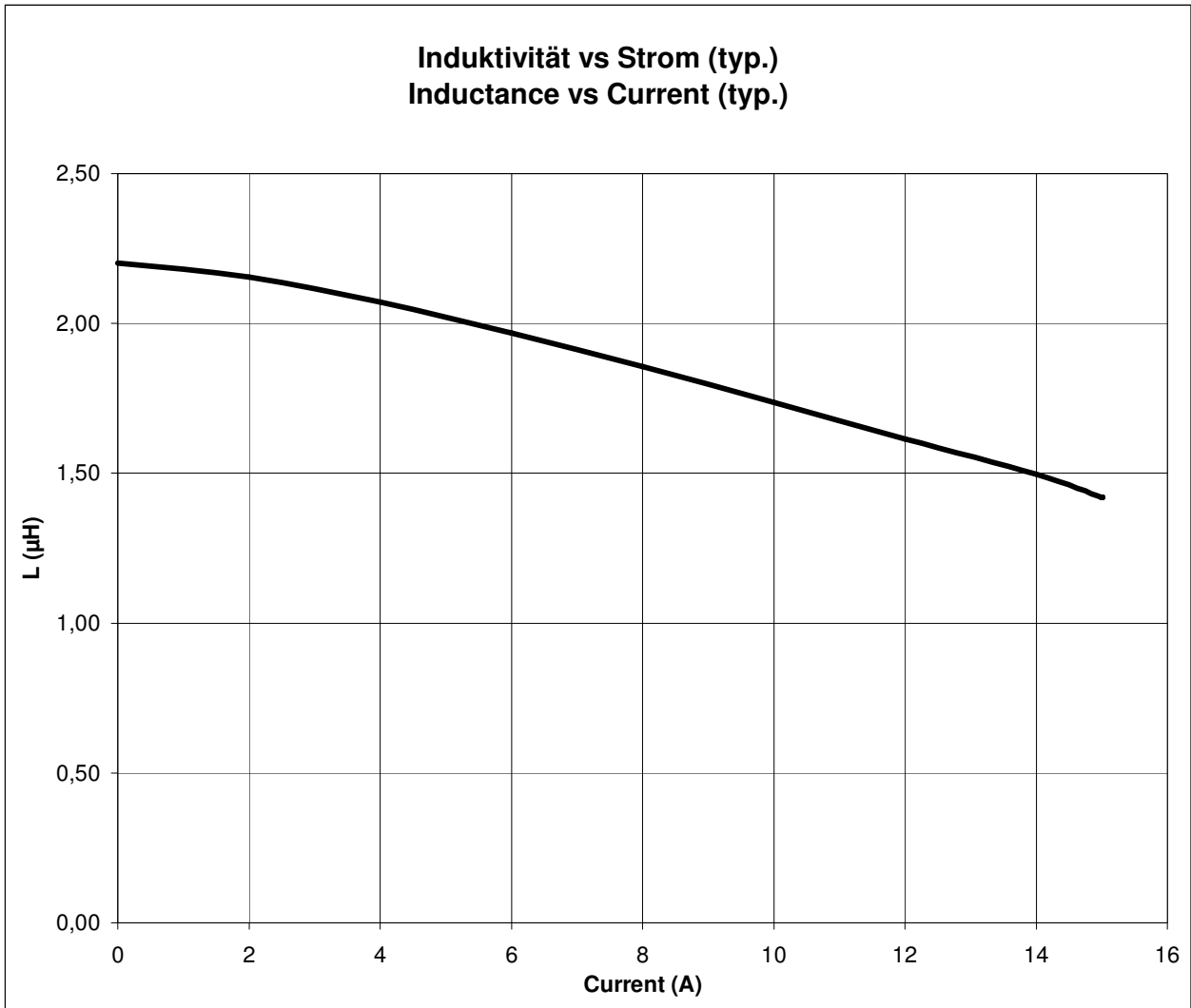

Freigabe erteilt / general release:	<b>Kunde / customer</b>			
Datum / date	Unterschrift / signature			
	<b>Würth Elektronik</b>	ME	Version 3	08-01-01
		ME	Version 2	04-11-25
		ME	Version 1	04-10-10
Geprüft / checked	Kontrolliert / approved	Name	Änderung / modification	Datum / date

### Würth Elektronik eiSos GmbH & Co. KG

D-74638 Waldenburg · Max-Eyth-Strasse 1 - 3 · Germany · Telefon (+49) (0) 7942 - 945 - 0 · Telefax (+49) (0) 7942 - 945 - 400  
<http://www.we-online.de>

# Spezifikation für Freigabe / specification for release

Kunde / customer : \_\_\_\_\_

Artikelnummer / part number : \_\_\_\_\_

**744311220**

LF



Bezeichnung : \_\_\_\_\_

description : \_\_\_\_\_

## I Temperaturanstieg / Temperature rise curve :

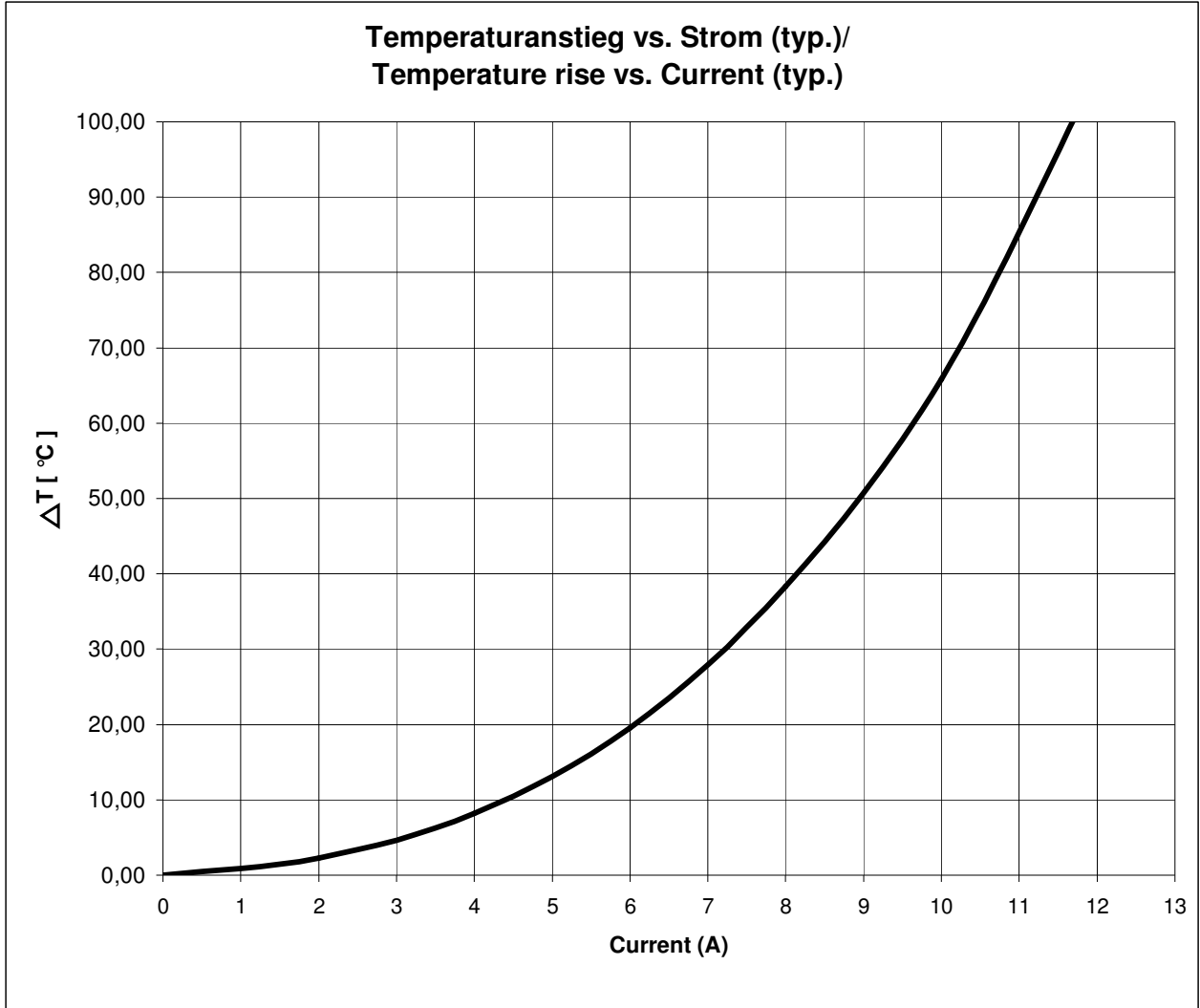

Freigabe erteilt / general release:	<b>Kunde / customer</b>			
Datum / date	Unterschrift / signature			
	<b>Würth Elektronik</b>	ME	Version 3	08-01-01
		ME	Version 2	04-11-25
Geprüft / checked	Kontrolliert / approved	ME	Version 1	04-10-10
		Name	<b>Änderung / modification</b>	Datum / date

### Würth Elektronik eiSos GmbH & Co. KG

D-74638 Waldenburg · Max-Eyth-Strasse 1 - 3 · Germany · Telefon (+49) (0) 7942 - 945 - 0 · Telefax (+49) (0) 7942 - 945 - 400  
<http://www.we-online.de>

# Spezifikation für Freigabe / specification for release

Kunde / customer : \_\_\_\_\_  
 Artikelnummer / part number : **744311220**

LF



Bezeichnung : **SPEICHERDROSSEL WE-HC**  
 description : **POWER-CHOKE WE-HC**

DATUM / DATE : 2008-01-01

## I Rollenspezifikation / tape and reel specification :

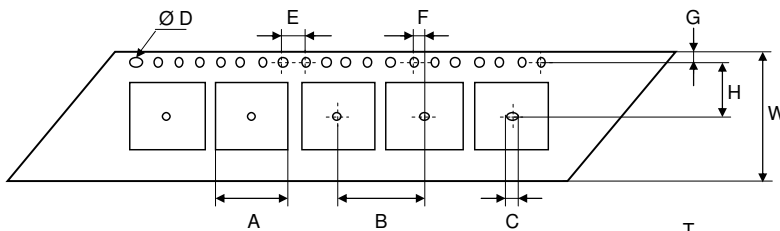

### Gurtspezifikation / Tape specification:

A	<b>7,55 ± 0,1</b>	mm
B	<b>12 ± 0,1</b>	mm
C	<b>1,50<sup>+0,1</sup><sub>-0,0</sub></b>	mm
D	<b>1,50<sup>+0,1</sup><sub>-0,0</sub></b>	mm
E	<b>4,00 ± 0,1</b>	mm
F	<b>2,00 ± 0,1</b>	mm
G	<b>1,75 ± 0,1</b>	mm
H	<b>7,5 ± 0,1</b>	mm
I	<b>7,3 ± 0,1</b>	mm
J	<b>4,65 ± 0,1</b>	mm
T	<b>0,35 ± 0,05</b>	mm
W	<b>16 ± 0,3</b>	mm

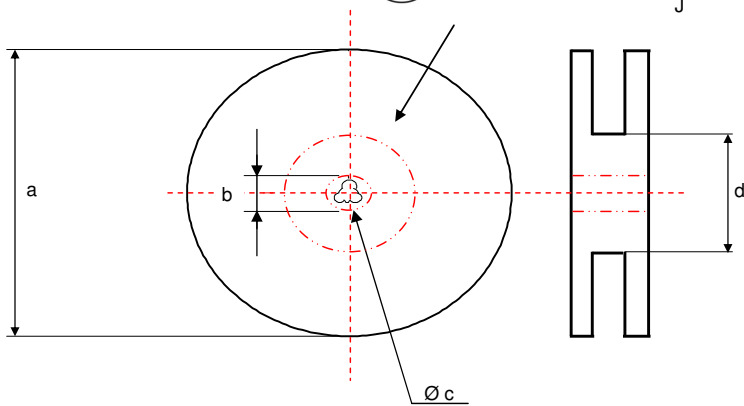
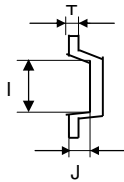

### Rollenspezifikation / Reel specification:

a	<b>330,0 ± 3,0</b>	mm
b	<b>20,2 min.</b>	mm
c	<b>13,00 ± 0,2</b>	mm
d	<b>75 ± 3,0</b>	mm

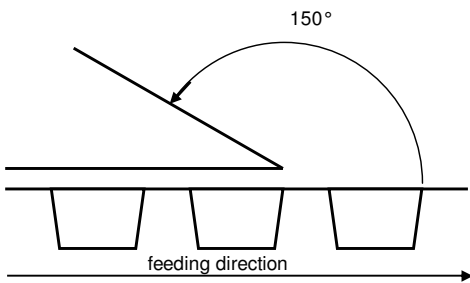

The Force for tearing off cover tape is 20 to 70 grams in arrow direction

Freigabe erteilt / general release:	Kunde / customer					
	Datum / date			Unterschrift / signature		
Geprüft / checked	Würth Elektronik					
	Kontrolliert / approved			ME	Version 2	04-11-25
				ME	Version 1	04-10-10
			Name	Änderung / modification	Datum / date	

This electronic component has been designed and developed for usage in general electronic equipment. Before incorporating this component into any equipment where higher safety and reliability is especially required or if there is the possibility of direct damage or injury to human body, for example in the range of aerospace, aviation, nuclear control, submarine, transportation, (automotive control, train control, ship control), transportation signal, disaster prevention, medical, public information network etc, Würth Elektronik eiSos GmbH must be informed before the design-in stage. In addition, sufficient reliability evaluation checks for safety must be performed on every electronic component which is used in electrical circuits that require high safety and reliability functions or performance.

## Würth Elektronik eiSos GmbH & Co. KG

D-74638 Waldenburg · Max-Eyth-Strasse 1 - 3 · Germany · Telefon (+49) (0) 7942 - 945 - 0 · Telefax (+49) (0) 7942 - 945 - 400  
<http://www.we-online.com>